



Wire Bin Roll File Assembly Instructions

For model WRF34

Tools Required: Screwdriver, pliers, or small wrench.

Parts Included:

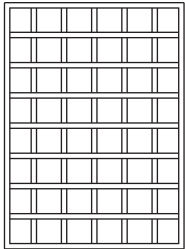

A 2pcs Large Grids

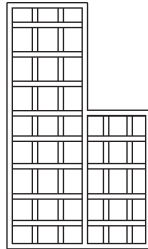

B 2pcs L-Shaped Side Grids

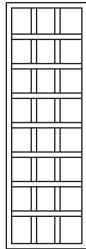

C 1pc Large Grid Divider

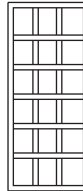

D 1pc Small Grid Divider



E 1pc Outer Support Frame

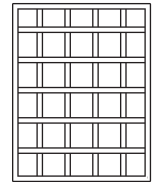

F 1pc Face Grid

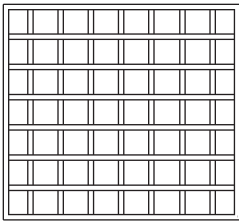

G 1pc Base Grid

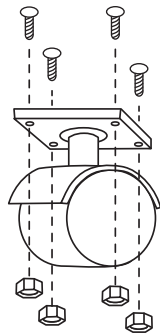

H 4pcs Caster Assemblies
(16 Screws, Nuts)



J 45pcs Small Plastic Clips



K 3pcs Large Plastic Clips



L 1pc Dust Protector Bottom Cover

Note:

Plastic clips can be snapped on easily by hand but pliers may be necessary for removal. Most grid sections require only 2 clips per side for support. For safety, clips attached on exterior of cart should be positioned with flanges facing inward.

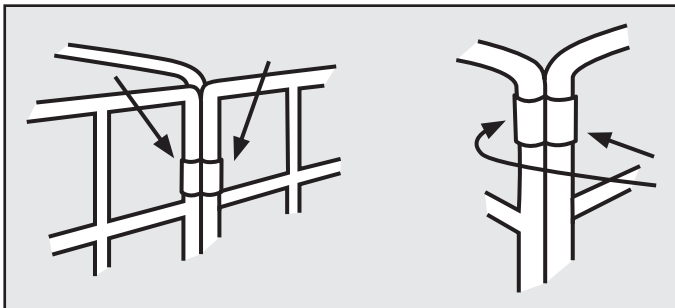

Clip Attachment

See reverse side for assembly

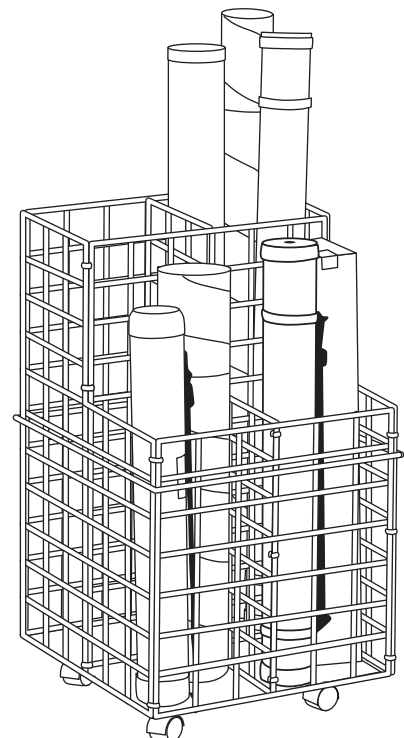

Assembled Rack

WRF34 Assembly Instructions

To Assemble:

- 1** Attach casters (**H**) to base grid (**G**).
- 2** Using small plastic clips (**J**), attach one large grid (**A**) to back of base grid as in *Figure 1*.
- 3** Attach two L-shaped side grids (**B**) to base and back as in *Figure 1*.
- 4** Place dust protector bottom cover (**L**) on base grid as in *Figure 1*.
- 5** Attach second large grid to side grids as in *Figure 2*.
- 6** Insert and attach large divider grid (**C**) as in *Figure 3*.
- 7** Attach face grid (**F**) to base grid and side grids as in *Figure 4*.
- 8** Attach small grid divider (**D**) as in *Figure 5*. Use large clips to attach (**D**) to (**C**).
- 9** Attach outer support frame (**E**) and extra clips where needed as in *Figure 6*. (Be sure to position support bar below the top of the face grid as shown for greater stability.)

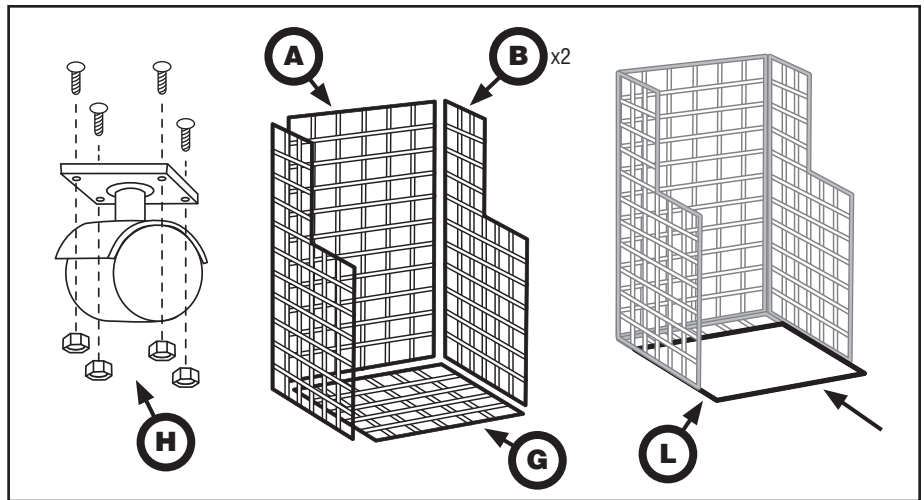

Figure 1

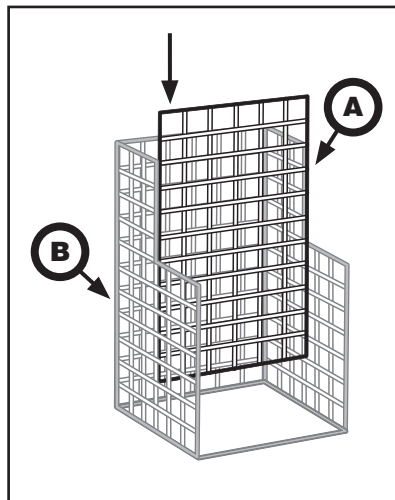

Figure 2

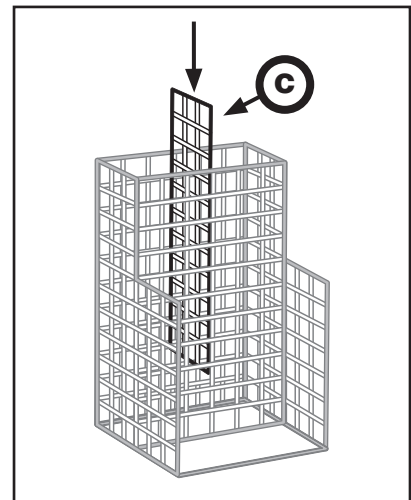

Figure 3

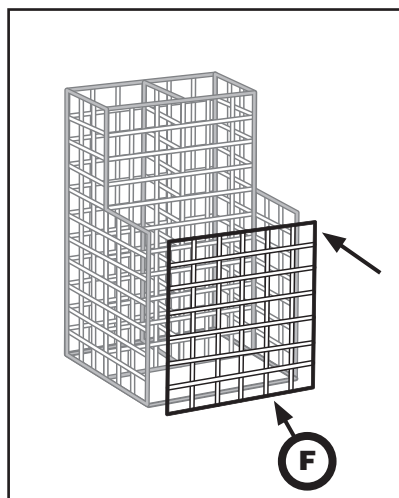

Figure 4

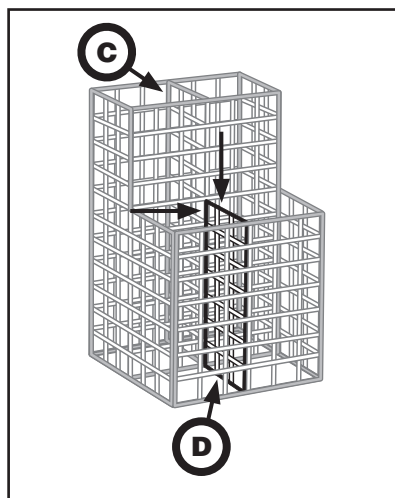

Figure 5

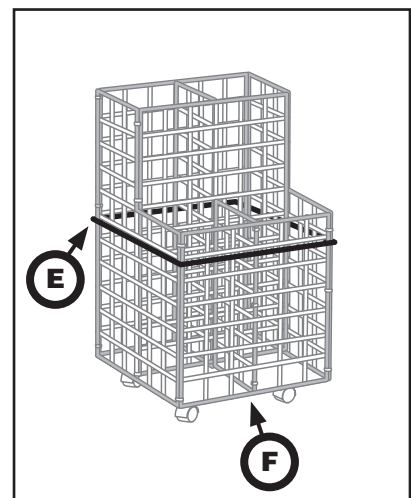

Figure 6

